

Technical data sheet

US 5 support FT

Item number: 6341527



U support of dimensions 50 x 50 mm with welded head plate. For fastening to horizontal concrete ceilings and steel girders. For bracket widths of 400 mm or more, or if the bracket is mounted at the end of a suspended support, we recommend the use of the spacer, type DSK 45.



St Steel

FT Hot-dip galvanised

Master data

Item number	6341527
Type	US 5 K 20 FT
Description 1	Support
Description 2	with welded head plate
Manufacturer	OBO
Dimension	50x50x200
Material	Steel
Surface	Hot-dip galvanised
Surface standard	DIN EN ISO 1461
Smallest sales unit	1
Unit of quantity	Piece
Weight	85 kg
Weight unit	kg/100 pc.

Technical data sheet

US 5 support FT

Item number: 6341527



Dimensions

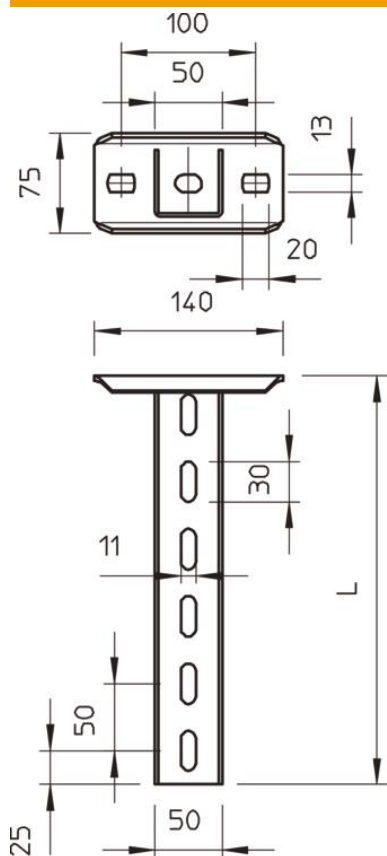

Length	200 mm
Width	50 mm
Height	50 mm
Dimension L	200 mm

Loads



Chara

Max. total
= 10 cm
of ETA(a)

Technical data

Version for	U profile
Bracket length 200	5.75 kN
Bracket length 400	3.1 kN
Bracket length 600	2.2 kN
Maintain electrical functions	yes
Material thickness	2.5 mm
Maximum tensile load	10 kN
With tothing	no