

# Technical data sheet

90° bend 60 FS

Item number: 6043208

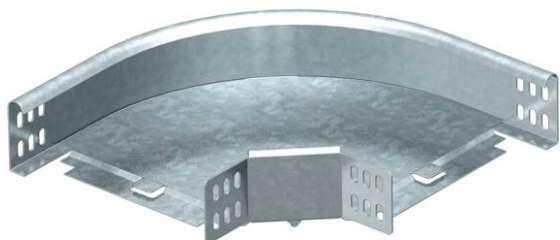

90° bend, horizontal, for all cable tray types of 60 mm side height.  
The fitting is shipped in an unmounted state.  
Including appropriate fastening material.



**St** Steel

**FS** Strip galvanized

## Master data

Item number	6043208
Type	RB 90 615 FS
Description 1	90° bend
Description 2	horizontal + angle connector
Manufacturer	OBO
Dimension	60x150
Material	Steel
Surface	Strip galvanized
Surface standard	DIN EN 10346
Smallest sales unit	1
Unit of quantity	Piece
Weight	88.4 kg
Weight unit	kg/100 pc.

## Dimensions

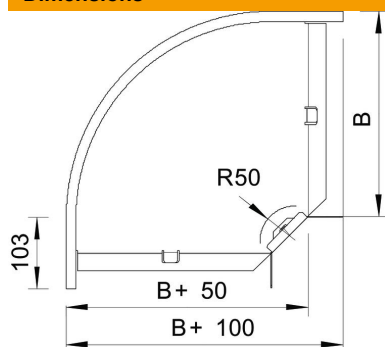

Width	150 mm
Width	6 in
Height	60 mm
Height	2 in
Dimension B	150 mm
Dimension R	50 mm

# Technical data sheet

90° bend 60 FS

Item number: 6043208



## Technical data

Bend (angle)	90°
Connector version	Supplied connectors
Maintain electrical functions	yes
Mounting perforation in base	no
NATO hole pattern	no
Change of direction	Horizontal
Rustproof steel, pickled	no
Side perforation	no
Wide-span version	no
Type of connector, cable support system	Screwed