

Technical data sheet

90° bend 60 FT

Item number: 7125100

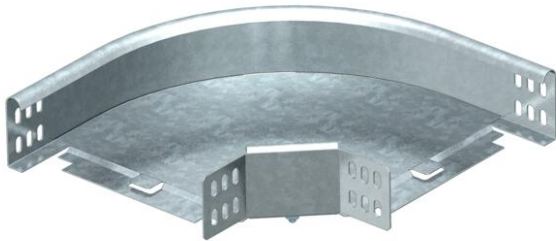

90° bend, horizontal, for all cable tray types of 60 mm side height.
The fitting is shipped in an unmounted state.
Including appropriate fastening material.
The 50 mm width has a rectangle shape and does not correspond to the image.



St

Steel

FT

Hot-dip galvanised

Master data

Item number	7125100
Type	RB 90 610 FT
Description 1	90° bend
Description 2	horizontal + angle connector
Manufacturer	OBO
Dimension	60x100
Material	Steel
Surface	Hot-dip galvanised
Surface standard	DIN EN ISO 1461
Smallest sales unit	1
Unit of quantity	Piece
Weight	77.6 kg
Weight unit	kg/100 pc.

Dimensions

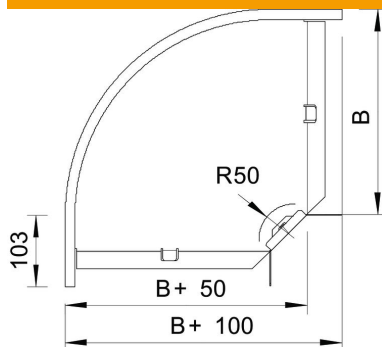

Width	100 mm
Width	4 in
Height	60 mm
Height	2 in
Dimension B	100 mm
Dimension R	50 mm

Technical data sheet

90° bend 60 FT

Item number: 7125100



Technical data

Bend (angle)	90°
Connector version	Supplied connectors
Type	Bend, rigid
Maintain electrical functions	yes
Mounting perforation in base	no
NATO hole pattern	no
Change of direction	Horizontal
Rustproof steel, pickled	no
Side perforation	no
Wide-span version	no
Type of connector, cable support system	Screwed