

# Technical data sheet

45° bend 85 FT

Item number: 7067119

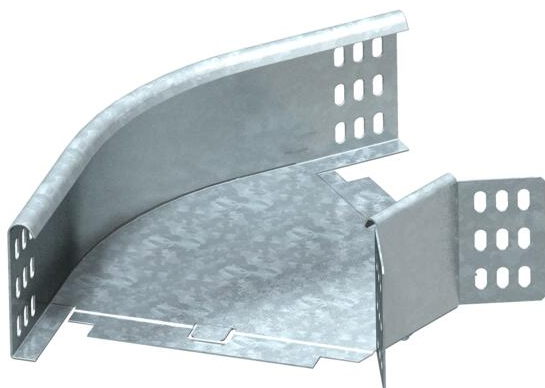

45° bend, horizontal, for all cable tray types of 85 mm side height.  
The fitting is shipped in an unmounted state. The WKV 85 angle connector is designed for 90° bends and can be adjusted to 45° on site.  
Including appropriate fastening material.



**St** Steel

**FT** Hot-dip galvanised

## Master data

Item number	7067119
Type	RB 45 810 FT
Description 1	45° bend
Description 2	horizontal + angle connector
Manufacturer	OBO
Dimension	85x100
Material	Steel
Surface	Hot-dip galvanised
Surface standard	DIN EN ISO 1461
Smallest sales unit	1
Unit of quantity	Piece
Weight	65 kg
Weight unit	kg/100 pc.

# Technical data sheet

45° bend 85 FT

Item number: 7067119



## Dimensions

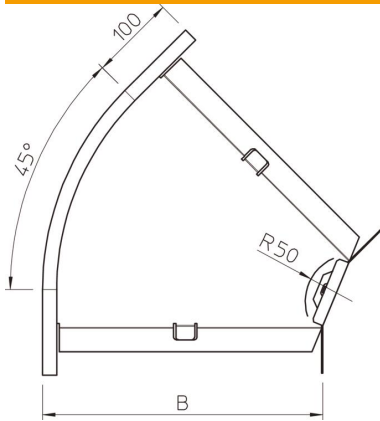

Width	100 mm
Width	4 in
Height	85 mm
Height	3 in
Plate thickness	1 mm
Dimension B	100 mm
Dimension R	50 mm

## Technical data

Bend (angle)	45°
Connector version	Supplied connectors
Maintain electrical functions	no
Mounting perforation in base	no
NATO hole pattern	no
Change of direction	Horizontal
Rustproof steel, pickled	no
Side perforation	no
Wide-span version	no
Type of connector, cable support system	Screwed