

# Technical data sheet

## 45° bend 110 FS

Item number: 7000634

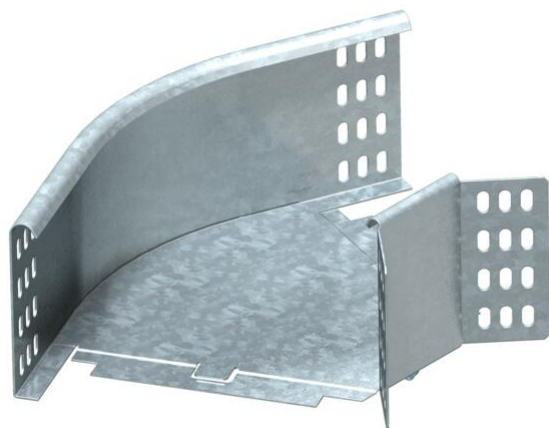

45° bend, horizontal, for all cable tray types of 110 mm side height.  
The fitting is shipped in an unmounted state. The WKV 110 angle connector is designed for 90° bends and can be adjusted to 45° on site.  
Including appropriate fastening material.



**St** Steel

**FS** Strip galvanized

### Master data

Item number	7000634
Type	RB 45 110 FS
Description 1	45° bend
Description 2	horizontal + angle connector
Manufacturer	OBO
Dimension	110x100
Material	Steel
Surface	Strip galvanized
Surface standard	DIN EN 10346
Smallest sales unit	1
Unit of quantity	Piece
Weight	70 kg
Weight unit	kg/100 pc.

# Technical data sheet

45° bend 110 FS

Item number: 7000634



## Dimensions

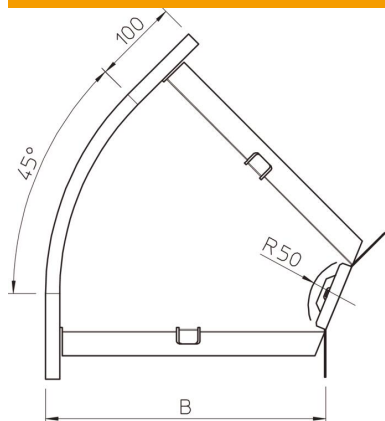

Width	100 mm
Width	4 in
Height	110 mm
Height	4 in
Dimension B	100 mm
Dimension R	50 mm

## Technical data

Bend (angle)	45°
Connector version	Supplied connectors
Maintain electrical functions	no
Mounting perforation in base	no
NATO hole pattern	no
Change of direction	Horizontal
Rustproof steel, pickled	no
Side perforation	no
Wide-span version	no
Type of connector, cable support system	Screwed