

# Technical data sheet

90° vertical bend, falling 60 A2

Item number: 7007161



90° vertical bend, falling, for all cable tray types of 60 mm side height.  
The vertical bend is pushed over the end of the cable tray and screwed tight.  
Fastening materials should be ordered separately.



**A2** Stainless steel

**2B** Bright, treated

## Master data

Item number	7007161
Type	RBV 640 F A2
Description 1	90° vertical bend
Description 2	falling
Manufacturer	OBO
Dimension	60x400
Material	Stainless steel
Surface	Bright, treated
Surface standard	
Smallest sales unit	1
Unit of quantity	Piece
Weight	130 kg
Weight unit	kg/100 pc.

# Technical data sheet

90° vertical bend, falling 60 A2

Item number: 7007161



## Dimensions

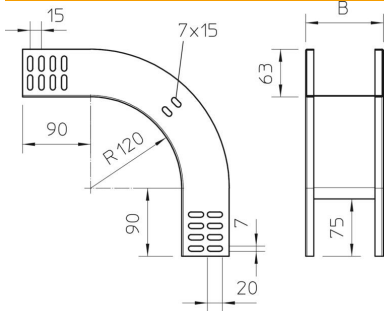

Width	400 mm
Width	16 in
Height	60 mm
Height	2 in
Plate thickness	1 mm
Dimension B	400 mm

## Technical data

Bend (angle)	90°
Connector version	Without connectors
Maintain electrical functions	no
Mounting perforation in base	no
NATO hole pattern	no
Change of direction	Vertical, falling
Rustproof steel, pickled	no
Side perforation	no
Wide-span version	no
Type of connector, cable support system	Screwed