

Technical data sheet

45° bend 60 A2

Item number: 7133235



45° bend, horizontal and unperforated, for all cable tray types of 60 mm side height.
Fitting, unperforated, in round design. The interior radius of the fitting is 150 mm.
Fastening materials should be ordered separately.



A2 Stainless steel

2B Bright, treated

Master data

Item number	7133235
Type	RBU 45 640 A2
Description 1	45° bend
Description 2	unperforated, round type
Manufacturer	OBO
Dimension	60x400
Material	Stainless steel
Surface	Bright, treated
Surface standard	
Smallest sales unit	1
Unit of quantity	Piece
Weight	300.7 kg
Weight unit	kg/100 pc.

Dimensions

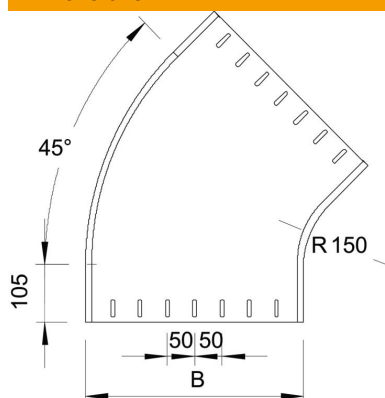

Width	400 mm
Width	16 in
Height	60 mm
Height	2 in
Plate thickness	1.5 mm
Dimension B	400 mm
Dimension R	150 mm

Technical data sheet

45° bend 60 A2

Item number: 7133235



Technical data

Bend (angle)	45°
Connector version	Without connectors
Maintain electrical functions	no
Mounting perforation in base	no
NATO hole pattern	no
Change of direction	Horizontal
Rustproof steel, pickled	no
Side perforation	no
Wide-span version	no
Type of connector, cable support system	Screwed