

Technical data sheet

90° bend VS 75 FT

Item number: 6487230



90° horizontal bend, with intelligent VS rung, for all cable ladder types of 75 mm side height.
Connectors should be ordered separately and in the appropriate quantity.



- St** Steel
- FT** Hot-dip galvanised

Master data

Item number	6487230
Type	LB 90 775 VS FT
Description 1	90° bend
Description 2	horizontal
Manufacturer	OBO
Dimension	75x750 R300
Material	Steel
Surface	Hot-dip galvanised
Surface standard	DIN EN ISO 1461
Smallest sales unit	1
Unit of quantity	Piece
Weight	812.06 kg
Weight unit	kg/100 pc.

Technical data sheet

90° bend VS 75 FT

Item number: 6487230



Dimensions

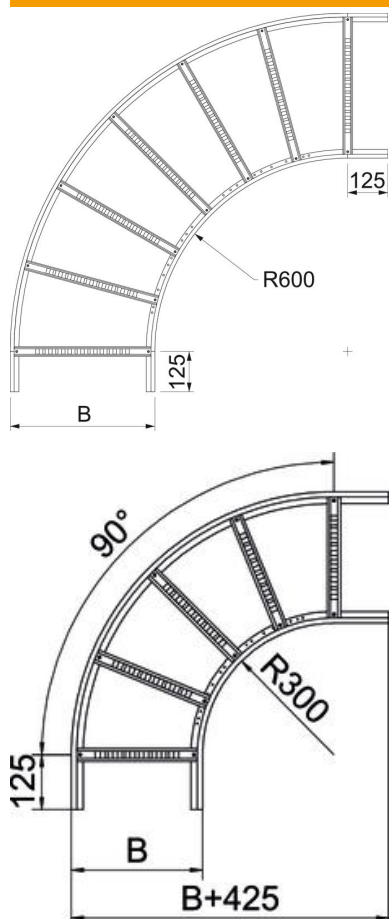

Width	750 mm
Height	75 mm

Technical data

Bend (angle)	90°
Change of direction	Horizontal
Rail thickness	1.5 mm