

Technical data sheet

90° bend 50 FS

Item number: 6487218



90° horizontal bend, with intelligent VS rung, for all cable ladder types of 50 mm side height.
Connectors should be ordered separately and in the appropriate quantity.



- St** Steel
- FS** Strip galvanized

Master data

Item number	6487218
Type	LB 90 560 VS FS
Description 1	90° bend
Description 2	horizontal
Manufacturer	OBO
Dimension	50x600 R300
Material	Steel
Surface	Strip galvanized
Surface standard	DIN EN 10346
Smallest sales unit	1
Unit of quantity	Piece
Weight	480.7 kg
Weight unit	kg/100 pc.

Technical data sheet

90° bend 50 FS

Item number: 6487218



Dimensions

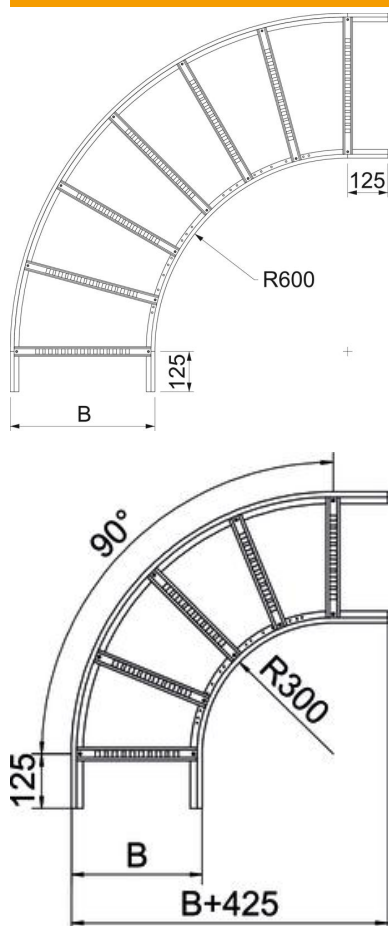

Width	600 mm
Height	50 mm

Technical data

Bend (angle)	90°
Change of direction	Horizontal
Rail thickness	1.5 mm