

Technical data sheet

Cover for 90° bend, horizontal FS

Item number: 6480151



Lock-on cover for the 90° bend.
The cover can be used with fittings of all side heights.



- St** Steel
- FS** Strip galvanized

Master data

Item number	6480151
Type	GKSDB 90 100 FS
Description 1	90° bend cover
Description 2	horizontal
Manufacturer	OBO
Dimension	B100mm
Material	Steel
Surface	Strip galvanized
Surface standard	DIN EN 10346
Smallest sales unit	1
Unit of quantity	Piece
Weight	36.55 kg
Weight unit	kg/100 pc.

Technical data sheet

Cover for 90° bend, horizontal FS

Item number: 6480151



Dimensions

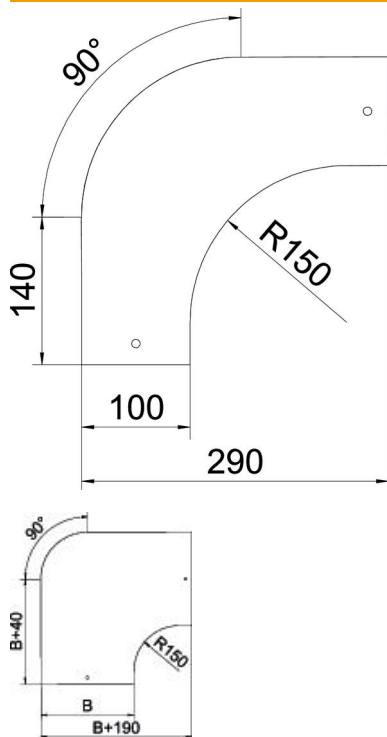

Width	100 mm
Plate thickness	1 mm
Dimension B	100 mm
Dimension D	8 mm

Technical data

Bend (angle)	90°
Fastening type	Sash lock
Maintain electrical functions	no
Suitable for mesh cable tray	no
Suitable for cable ladder	yes
Suitable for cable tray	yes
Change of direction	Horizontal
Rustproof steel, pickled	no
Hinged	no