

Technical data sheet

Cover for 45° bend, horizontal FT

Item number: 6483192



Lock-on cover for the 45° bend.

The cover can be used with fittings of all side heights.

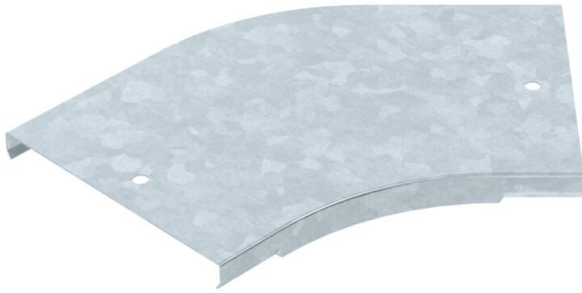

St Steel

FT Hot-dip galvanised

Master data

Item number	6483192
Type	GKSDB 45 150 FT
Description 1	45° bend cover
Description 2	horizontal
Manufacturer	OBO
Dimension	B150mm
Material	Steel
Surface	Hot-dip galvanised
Surface standard	DIN EN ISO 1461
Smallest sales unit	1
Unit of quantity	Piece
Weight	37.4 kg
Weight unit	kg/100 pc.

Technical data sheet

Cover for 45° bend, horizontal FT

Item number: 6483192



Dimensions

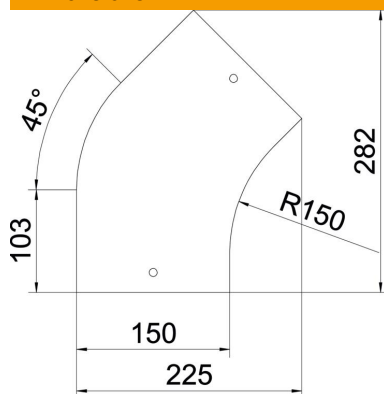

Width	150 mm
Dimension B	150 mm
Dimension D	8 mm

Technical data

Bend (angle)	45°
Fastening type	Locking
Maintain electrical functions	no
Suitable for mesh cable tray	no
Suitable for cable ladder	no
Suitable for cable tray	yes
Change of direction	Horizontal
Rustproof steel, pickled	no
Hinged	no