

# Technical data sheet

## Cover for 45° bend FS

Item number: 7128886

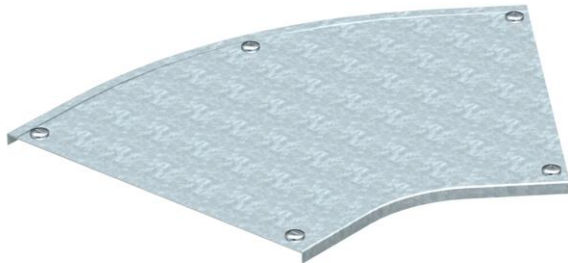

Cover for 45° bend with pre-mounted turn buckle.  
The cover can be used with fittings of all side heights.



- St** Steel
- FS** Strip galvanized

### Master data

Item number	7128886
Type	DFB 45 400 FS
Description 1	45° bend cover
Description 2	with sash locks, RB 45 400
Manufacturer	OBO
Dimension	B400mm
Material	Steel
Surface	Strip galvanized
Surface standard	DIN EN 10346
Smallest sales unit	1
Unit of quantity	Piece
Weight	218.6 kg
Weight unit	kg/100 pc.

### Dimensions

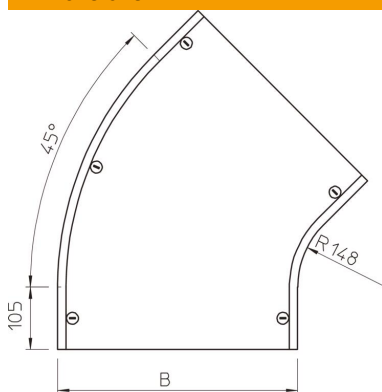

Width	400 mm
Width	16 in
Height	35 mm
Plate thickness	0.05 in
Plate thickness	1.25 mm
Dimension B	400 mm
Dimension H	15 mm
Dimension R	148 mm

# Technical data sheet

Cover for 45° bend FS

Item number: 7128886



## Technical data

Bend (angle)	45°
Number of turn buckles	5 St.
Fastening type	Sash lock
Maintain electrical functions	no
Suitable for mesh cable tray	no
Suitable for cable ladder	no
Suitable for cable tray	yes
Change of direction	Horizontal
Rustproof steel, pickled	no
Hinged	no