

Technical data sheet

Spacer clip 733 A2

Item number: 1362976



Spacer clip for the installation of pipes and cables on walls, ceilings and floors. With self-locking cover. Fastening via slot.

Approved for the maintenance of electrical function according to DIN 4102 Part 12, maintenance of electrical function classes E 30 to E 90.



A2 Stainless steel

Master data

Item number	1362976
Type	ASL 733 10 A2
Description 1	Distance saddle
Description 2	with slot
Manufacturer	OBO
Dimension	8-10mm
Material	Stainless steel
Smallest sales unit	25
Unit of quantity	Piece
Weight	1.804 kg
Weight unit	kg/100 pc.

Technical data sheet

Spacer clip 733 A2

Item number: 1362976



Dimensions

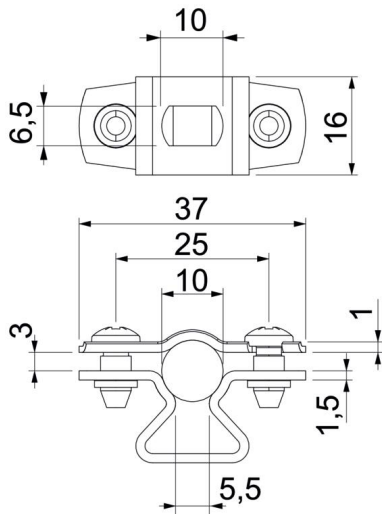

Dimension A	37 mm
Dimension B	25 mm
Dimension b	16 mm
Dimension d max.	10 mm
Dimension d min.	8 mm
Dimension L	10 mm
Dimension s	5.5 mm
Dimension t1 (mm)	1
Dimension t2 (mm)	1.5
Dimension x	3 mm

Technical data

Distance to the wall	yes
Number of cables/pipes	1
Version for	Closed
For diameter	8 - 10
Suitable in fire protection area	no
Halogen-free	yes
Plastic-covered	no
Material thickness	1.5 mm
Clamping range D, max.	10 mm
Clamping range D, min.	8 mm
UV-resistant	yes