

# Technical data sheet

## Clamp clip, single, plastic pressure trough, FT

Item number: 1160907



Suitable for all C profile rails with slot width 16–17 mm.  
Hot-dip galvanized steel clip and bolt, polypropylene pressure trough, halogen-free, colour light grey RAL 7035.  
Version with welding and/or locknuts for use under difficult circumstances and for shake protection on request.



**St** Steel

**FT** Hot-dip galvanized

### Master data

Item number	1160907
Type	2056 90 FT
Description 1	Clamp clip
Manufacturer	OBO
Dimension	82-90mm
Material	Steel
Surface	Hot-dip galvanized
Surface standard	DIN EN ISO 1461
Smallest sales unit	25
Unit of quantity	Piece
Weight	26.2 kg
Weight unit	kg/100 pc.

# Technical data sheet

## Clamp clip, single, plastic pressure trough, FT

Item number: 1160907



### Dimensions

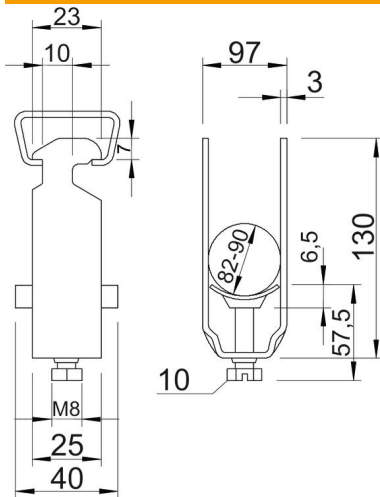

Dimension A	25 mm
Dimension B	97 mm
Dimension C	40 mm
Dimension G (mm)	M8
Dimension H	130 mm
Dimension L	57.5 mm
Dimension t	3 mm
Dimension x	6.5 mm

### Technical data

Number of cables/pipes	1
for rail with slot width (with interval), max.	17 mm
for rail with slot width (with interval), min.	16 mm
Halogen-free	yes
Max. Tightening torque	5 Nm
With plastic trough	yes
With metal trough	no
Mounting type	Profile rail
Impact-resistant	no
Clamping range D, max.	90 mm
Clamping range D, min.	82 mm
Surface addition	hot galvanised
Material addition	Steel
With counter-trough	no
Material of trough	Plastic
Material quality of trough	Polypropylene