

Technical data sheet

Locknut, PG thread, light grey

Item number: 2048299



Locknut DIN 46320, with PG thread DIN 40430.



PA Polyamide

Master data

Item number	2048299
Type	116 VDE PG29 PA
Description 1	Locknut
Manufacturer	OBO
Dimension	PG29
Colour	Light grey; RAL 7035
Material	Polyamide
Smallest sales unit	50
Unit of quantity	Piece
Weight	1.1 kg
Weight unit	kg/100 pc.

Technical data sheet

Locknut, PG thread, light grey

Item number: 2048299



Dimensions

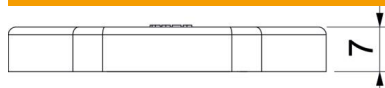

Dimension E	50 mm
Dimension L	7 mm

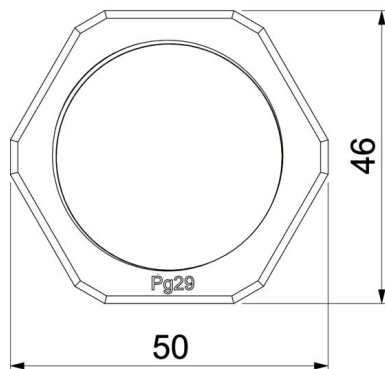

Technical data

Thread	Pg_29
Thread type	PG
Nominal thread size metric/PG	29
Fibre-glass reinforced	no
Halogen-free	yes
Impact-resistant	no
WAF	46